

TOOLS

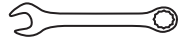

Channel-lock pliers



5/8" Wrench



Socket wrench



1/2" Deep Socket

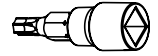

Security tool
T-40 security torx
(stored in vehicle)

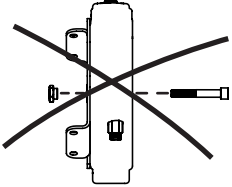

DO NOT remove center bolt

Need Help?



(650) - 741 - 3231

1. UNSCREW HOSES

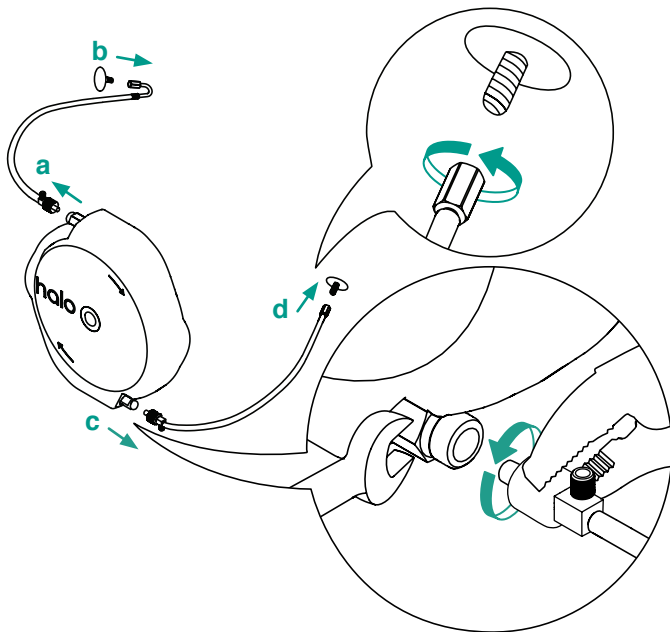

2. REMOVE HALO

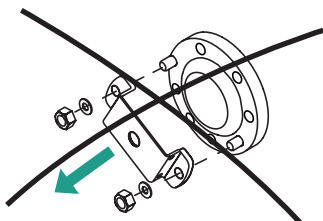
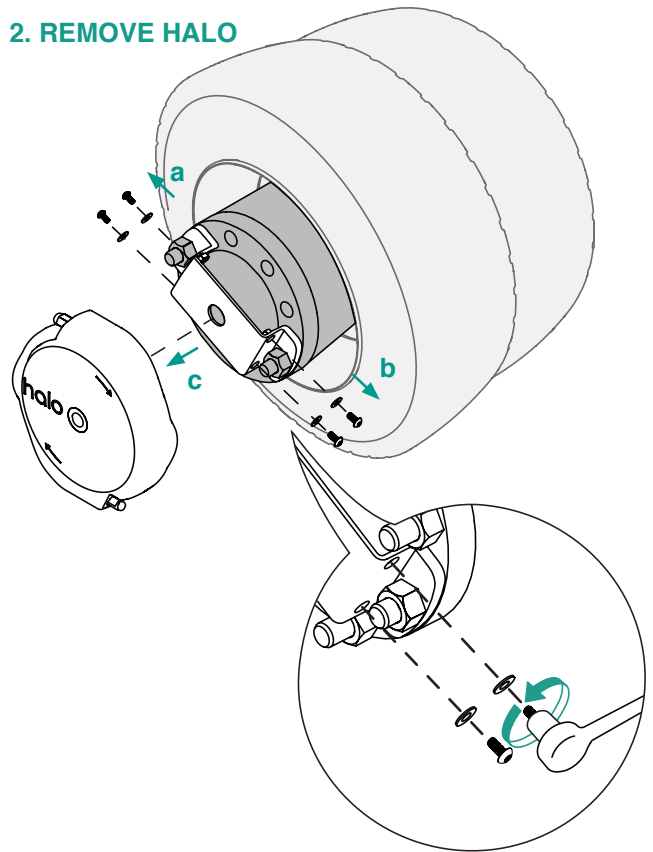

DO NOT remove bracket

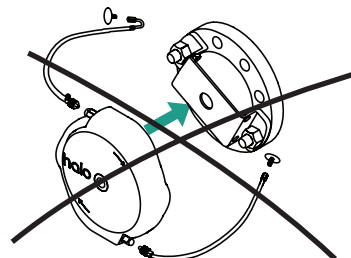

DO NOT reinstall
until vehicle returns
to shop.

